

Diamond

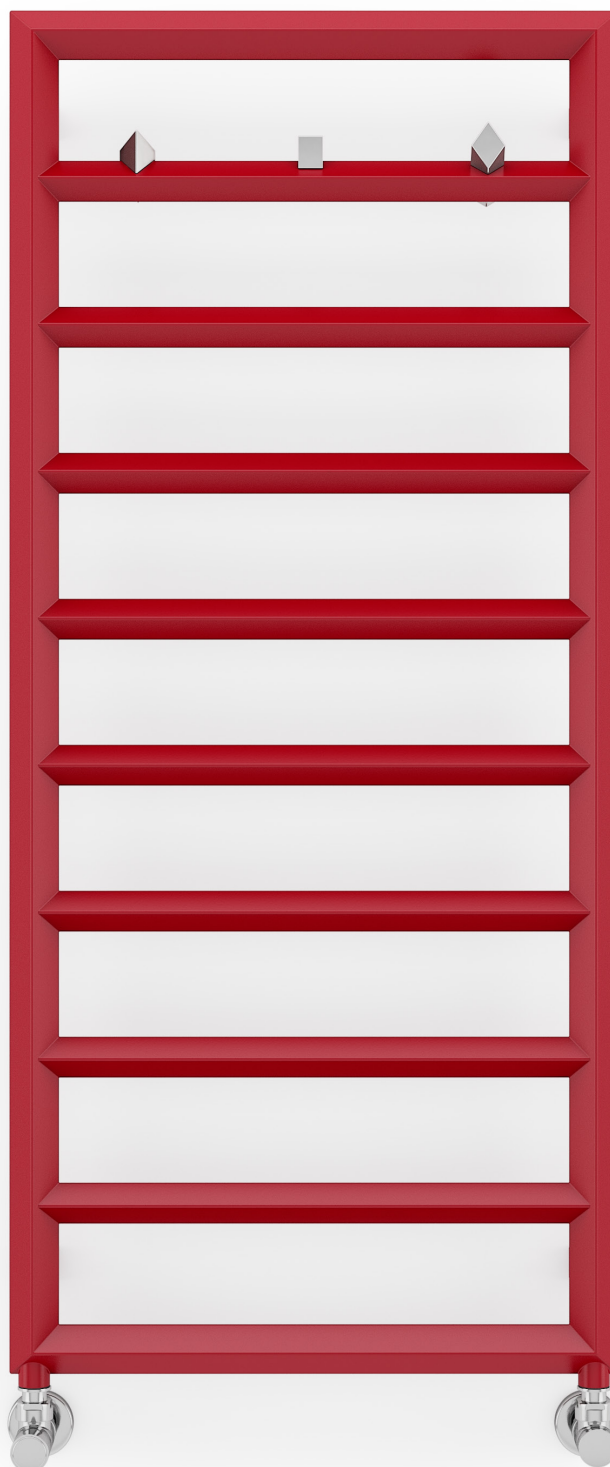

Diamond 1120↓ x 500↔ SX
kolor: RAL 3031

Zestaw regulacyjny kątowy, chrom
Zestaw maskujący podwójny, chrom
Wieszaki SPARK



TERMA

SINCE 1990





Podłączenia standardowe:



Podłączenia opcjonalne:

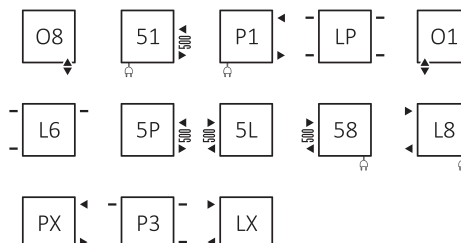

Grzejniki elektryczne:

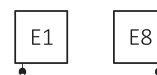

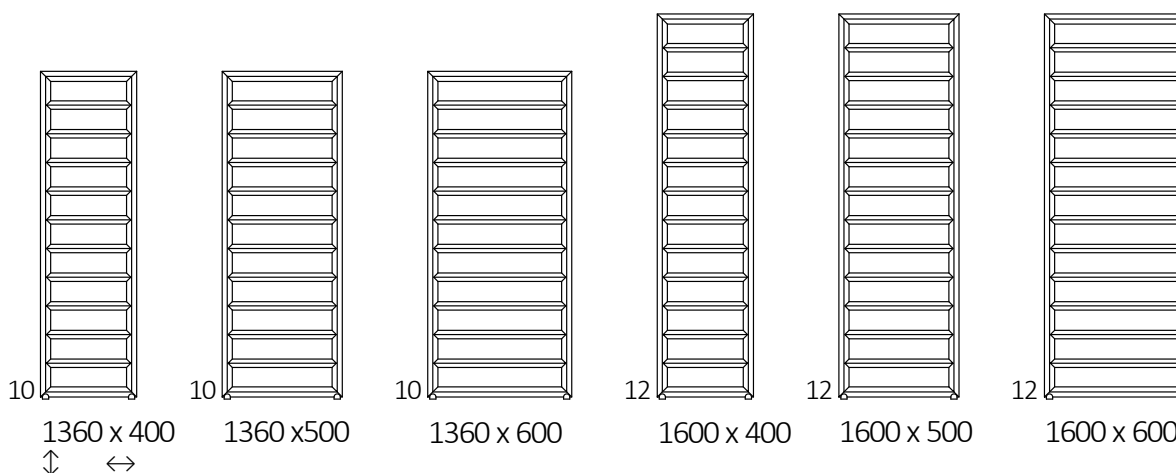
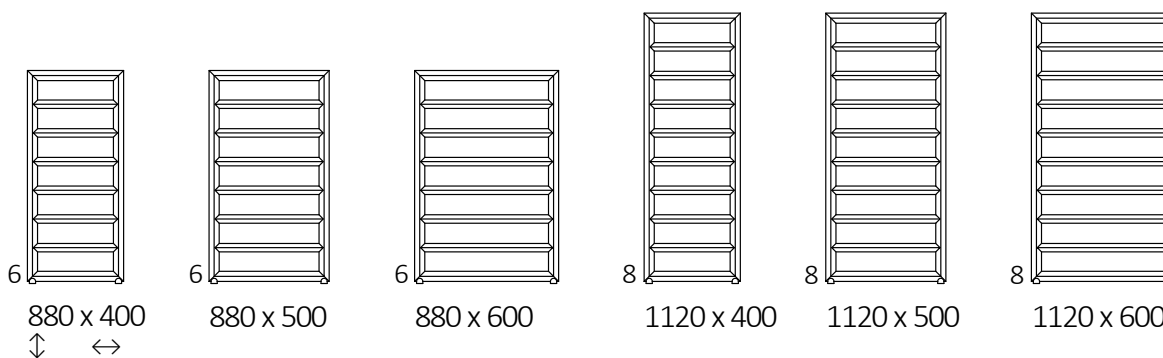

Dostępne rozmiary:





Dane techniczne:

Ciśnienie robocze: 1000 kPa Maksymalna temperatura pracy: 95°C

A ↓ [mm]	B ↔ [mm]	C1 [mm]	C2 [mm]	75/65/20°C [W]	55/45/20°C [W]	 [W]	D [mm]	E [mm]	F [mm]	 [dm ³]	 [kg]	Kod produktu <small>Kod konfiguracji s. 5</small>
Farba proszkowa												
880	400	50	360	270	146	300	360	720	80	2,58	5,51	WGDIM088040
880	500	50	460	320	174	300	460	720	80	2,97	6,40	WGDIM088050
880	600	50	560	367	199	400	560	720	80	3,36	7,29	WGDIM088060
1120	400	50	360	340	184	400	360	960	80	3,26	6,87	WGDIM112040
1120	500	50	460	400	217	400	460	960	80	3,74	7,99	WGDIM112050
1120	600	50	560	461	249	400	560	960	80	4,22	9,10	WGDIM112060
1360	400	50	360	410	221	400	360	1200	80	3,93	8,25	WGDIM136040
1360	500	50	460	484	261	600	460	1200	80	4,51	9,59	WGDIM136050
1360	600	50	560	554	299	600	560	1200	80	5,09	10,91	WGDIM136060
1600	400	50	360	480	259	400	360	1440	80	4,61	9,62	WGDIM160040
1600	500	50	460	563	304	600	460	1440	80	5,28	11,18	WGDIM160050
1600	600	50	560	647	349	600	560	1440	80	5,96	12,74	WGDIM160060
Powłoka galwaniczna												
880	400	50	360	189	102	200	360	720	80	2,58	5,33	WGDIM088040
880	500	50	460	224	122	200	460	720	80	2,97	6,19	WGDIM088050
880	600	50	560	257	139	300	560	720	80	3,36	7,05	WGDIM088060
1120	400	50	360	238	129	200	360	960	80	3,26	6,65	WGDIM112040
1120	500	50	460	280	152	300	460	960	80	3,74	7,73	WGDIM112050
1120	600	50	560	323	174	300	560	960	80	4,22	8,80	WGDIM112060
1360	400	50	360	287	155	300	360	1200	80	3,93	7,98	WGDIM136040
1360	500	50	460	339	183	400	460	1200	80	4,51	9,27	WGDIM136050
1360	600	50	560	388	209	400	560	1200	80	5,09	10,55	WGDIM136060
1600	400	50	360	336	181	400	360	1440	80	4,61	9,30	WGDIM160040
1600	500	50	460	394	213	400	460	1440	80	5,28	10,81	WGDIM160050
1600	600	50	560	453	244	400	560	1440	80	5,96	12,31	WGDIM160060



Rysunek techniczny:

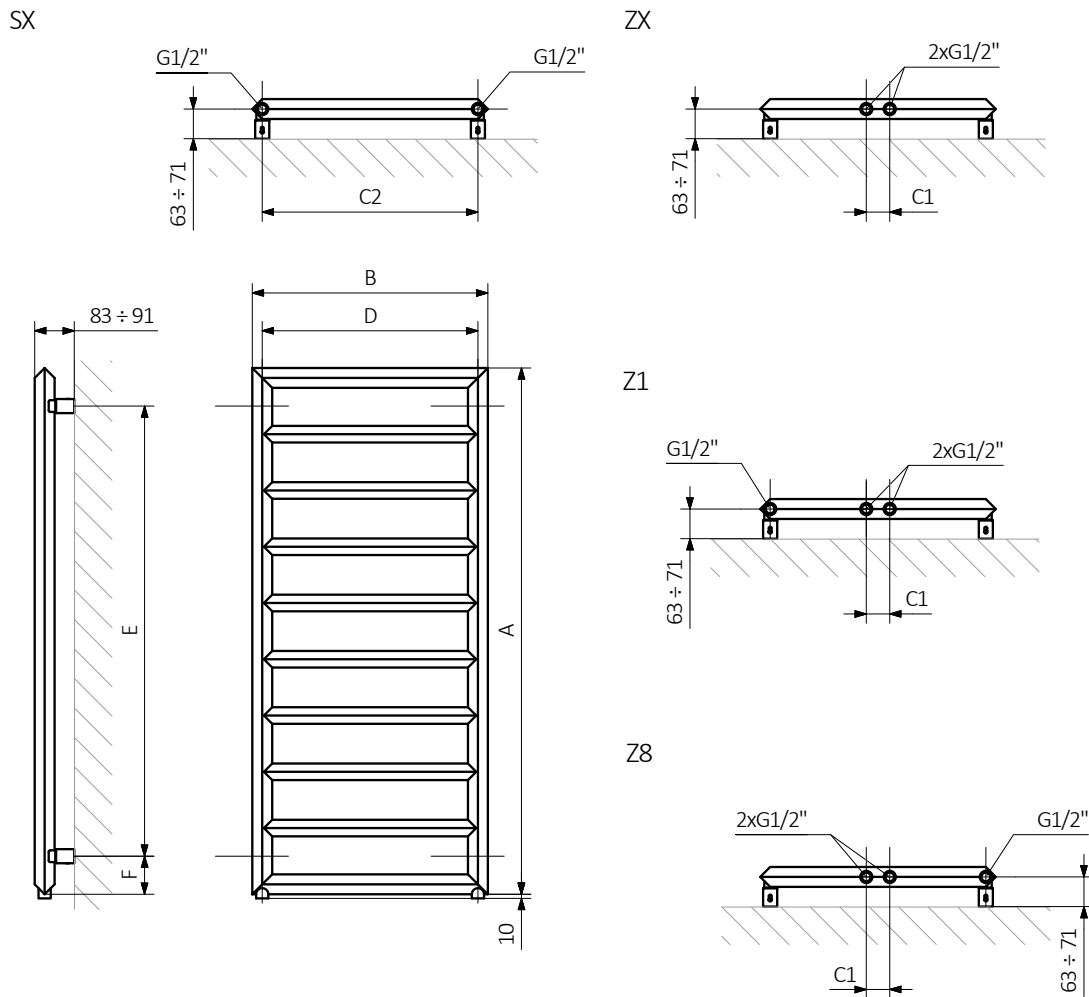

A – wysokość B – szerokość C1-C5 – rozstaw połączeń D – rozstaw konsol w poziomie E – rozstaw konsol w pionie, F – odległość od osi dolnej konsoli do dolnej krawędzi kolektora

Kolektor:

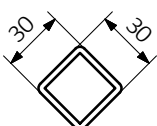

Rurka:

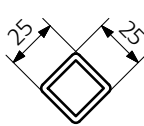



Legenda



Grzejnik dostępny w wersji c.o.



Grzejnik przystosowany do pracy jako grzejnik c.o. z podłączoną grzałką elektryczną.



Grzejnik dostępny w wersji elektrycznej z przewodem grzejnym lub z czynnikiem grzewczym i grzałką. Produkt fabrycznie przetestowany i gotowy do użytku.



Podstawowy wariant podłączenia grzejnika. Ikona wskazuje sposób zasilania oraz powrotu wody w danym podłączeniu oraz umiejscowienie wkładki termostatycznej oraz grzałki, jeśli istnieje możliwość ich zamontowania.



Moc grzejnika elektrycznego lub sugerowana moc grzałki przeznaczonej do grzejnika c.o.



Waga.



Pojemność.



Grzejnik dostępny także w wersji chromowanej.

Wieszaki SPARK

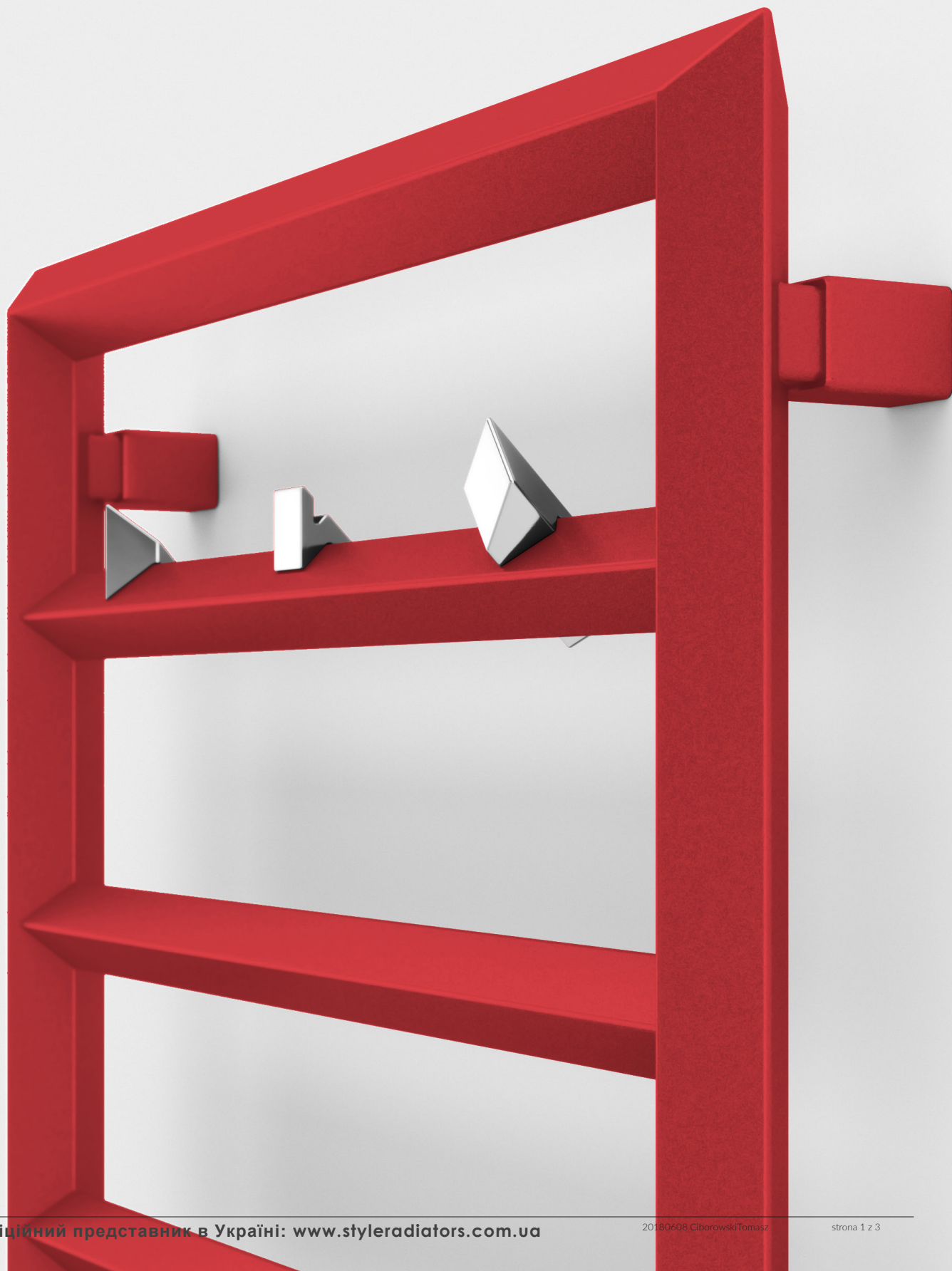

Wieszaki SPARK



Spark 1

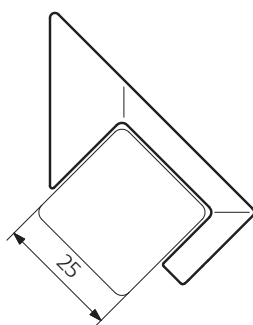

Spark 2

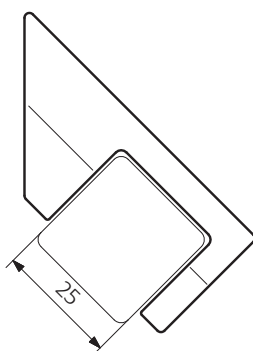
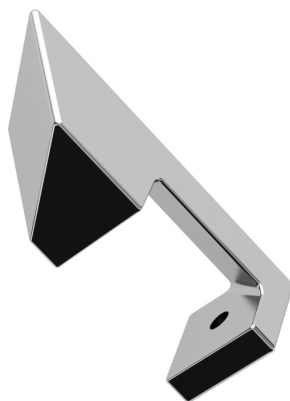

Spark 3

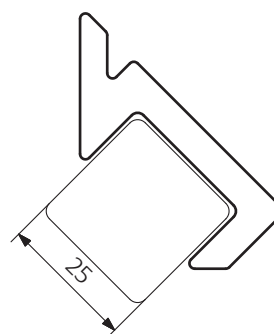
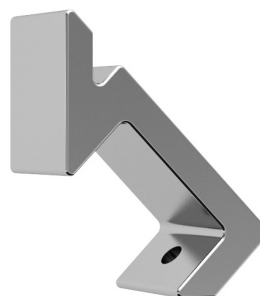

Wersja	Rozmiar [mm]	Kolor	Kod produktu
1	25	chrom	WRWSP1025
2	25	chrom	WRWSP2025
3	25	chrom	WRWSP3025