

# Triga



kolor  
w cenie





kolor  
w cenie

projekt: *Terma*

## Podłączenia standardowe:

A ↓ 560÷1900:

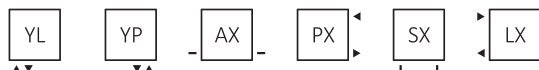

A ↓ 560÷610:

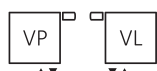

A ↓ 900÷1900:



## Podłączenia opcjonalne:

A ↓ 560÷1900:

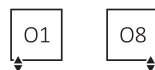

A ↓ 560÷610:

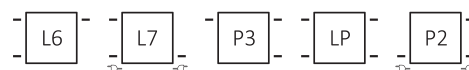
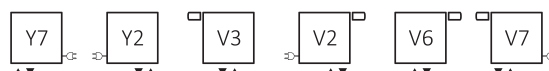

A ↓ 900÷1900:

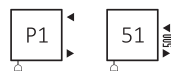
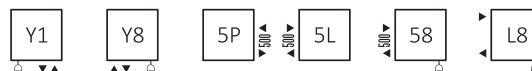

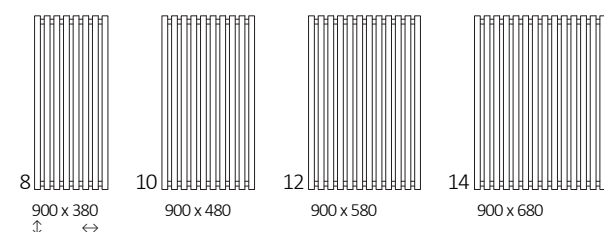
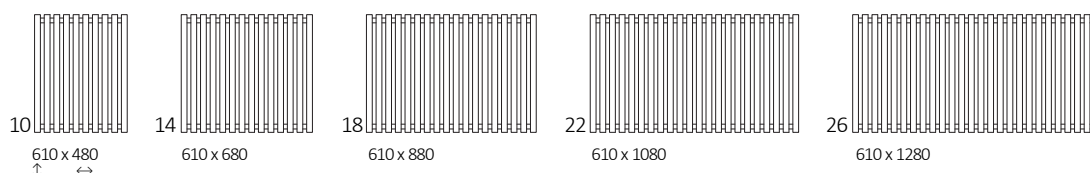
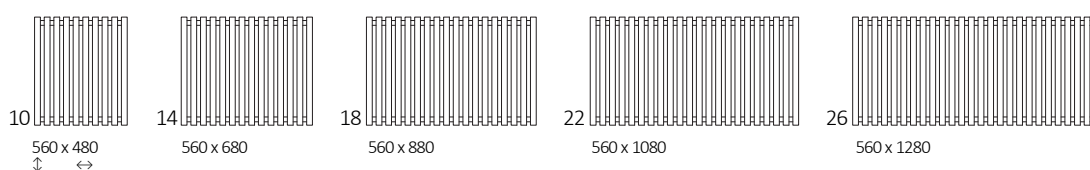

## Dostępne rozmiary:





## Dane techniczne:

Ciśnienie robocze: 800 kPa    Maksymalna temperatura pracy: 95°C

A ↓ [mm]	B ↔ [mm]	C1 [mm]	75/65/20°C [W]	55/45/20°C [W]	 [W]	D [mm]	E [mm]	F [mm]	H [dm³]	 [kg]	Kod produktu
560	480	50	356	192	400	450	380	90	5,72	10,14	WGTRG056048
560	680	50	504	272	600	650	380	90	8,01	14,25	WGTRG056068
560	880	50	652	352	600	850	380	90	10,31	18,36	WGTRG056088
560	1080	50	800	431	800	1050	380	90	12,60	22,47	WGTRG056108
560	1280	50	948	511	1000	1250	380	90	14,90	26,58	WGTRG056128
610	480	50	391	210	400	450	430	90	6,22	10,93	WGTRG061048
610	680	50	554	298	600	650	430	90	8,71	15,36	WGTRG061068
610	880	50	717	385	800	850	430	90	11,21	19,79	WGTRG061088
610	1080	50	880	473	800	1050	430	90	13,70	24,22	WGTRG061108
610	1280	50	1043	560	1000	1250	430	90	16,19	28,65	WGTRG061128
900	380	50	459	242	400	350	720	90	7,29	12,40	WGTRG090038
900	480	50	580	306	6000	450	720	90	9,11	15,54	WGTRG090048
900	580	50	701	370	800	550	720	90	10,94	18,67	WGTRG090058
900	680	50	821	433	800	650	720	90	12,76	21,81	WGTRG090068



kolor  
w cenie

## Rysunek techniczny:

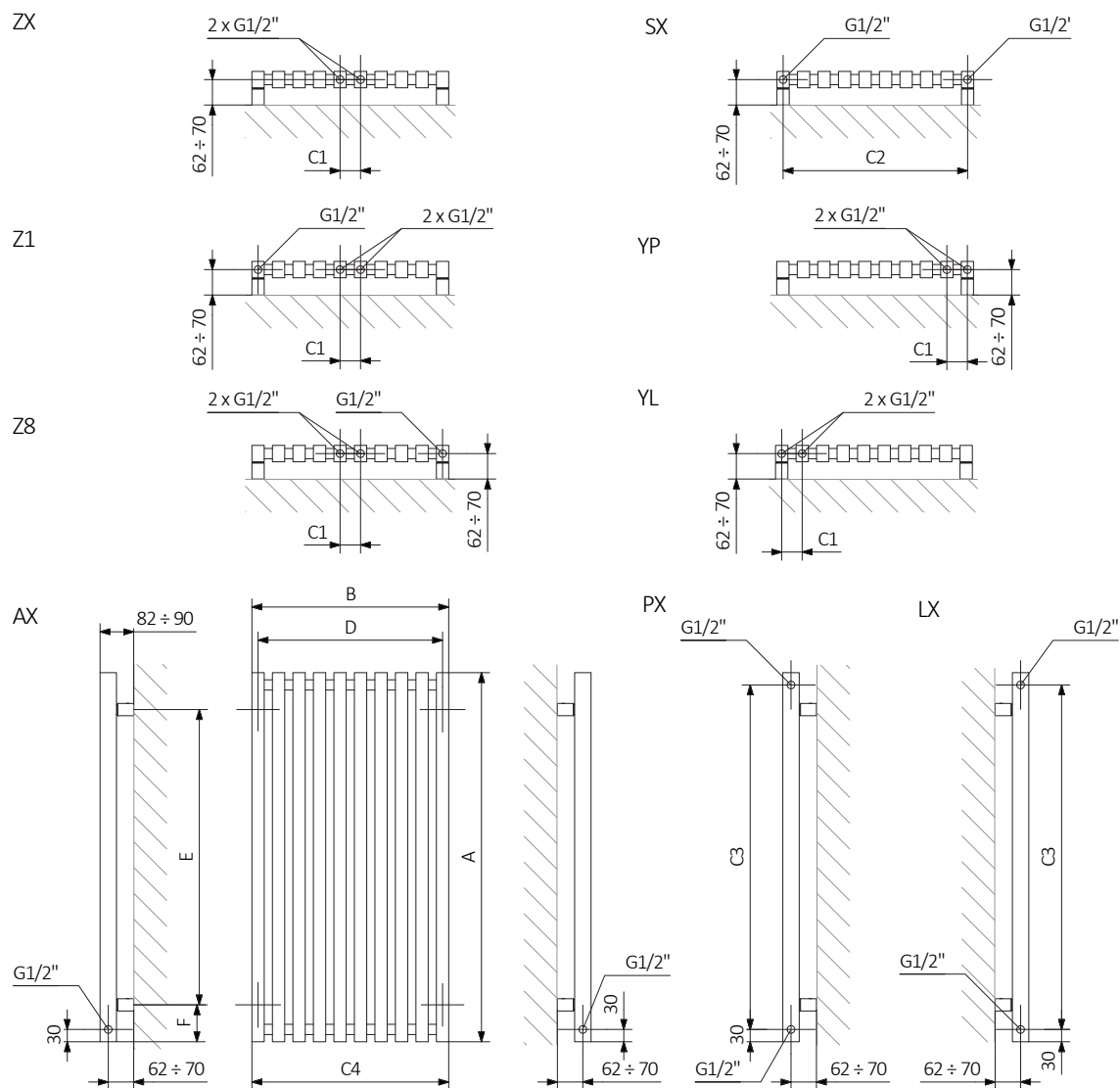

A – wysokość B – szerokość C1-C4 – rozstaw połączeń D – rozstaw mocowań w poziomie E – rozstaw mocowań w pionie, F – odległość od dolnej osi mocowań do dolnej krawędzi kolektora

**Kolektor:**

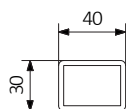

**Rurka:**

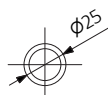



kolor  
w cenie

## Rysunek techniczny:

VP

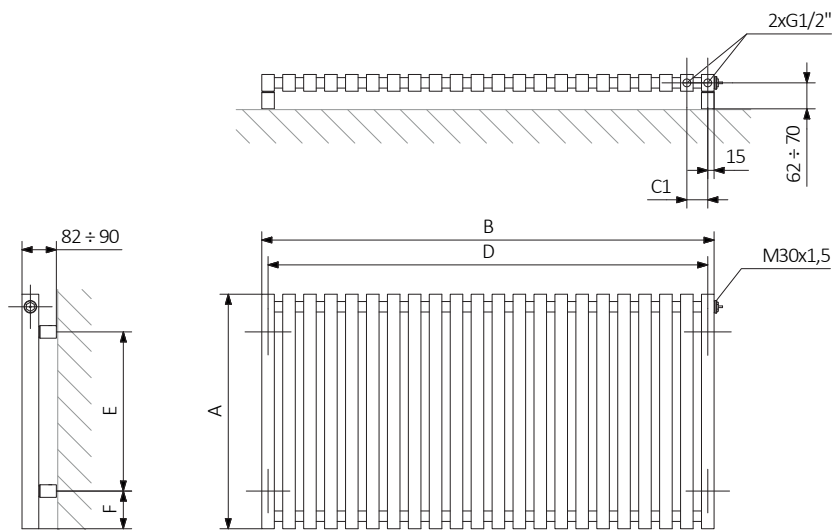

VL

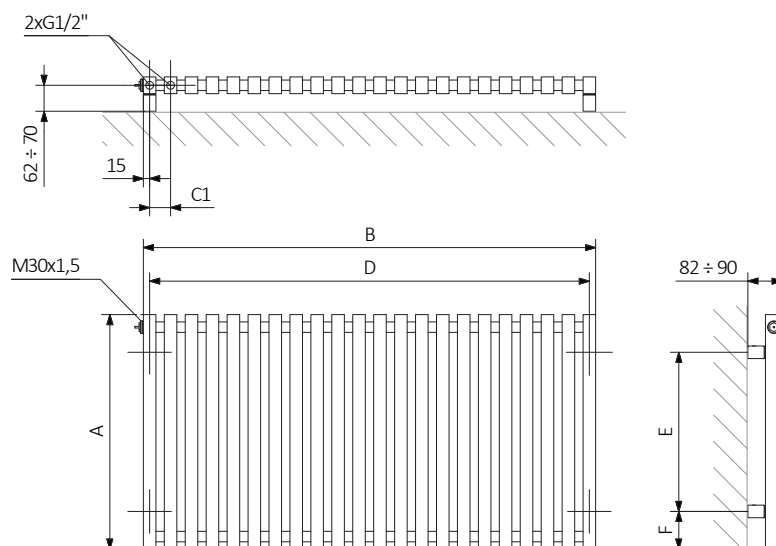

A – wysokość B – szerokość C1-C4 – rozstaw połączeń D – rozstaw mocowań w poziomie E – rozstaw mocowań w pionie,  
F – odległość od dolnej osi mocowań do dolnej krawędzi kolektora

Kolektor:

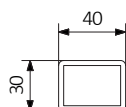

Rurka:

